

Package Dimensions:

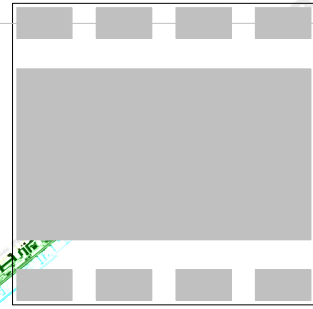
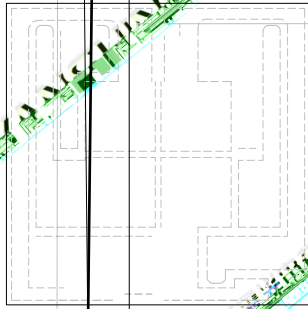

ÜÉ

ÜÉ

ÜÉ

ÜÉ ÖÉ ÖÉ YÉ

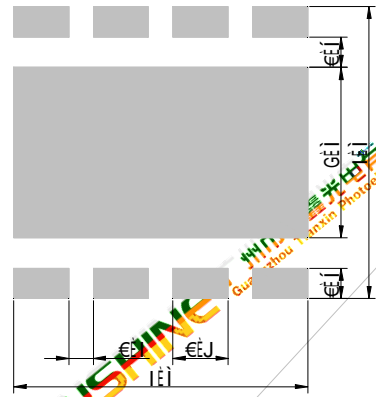
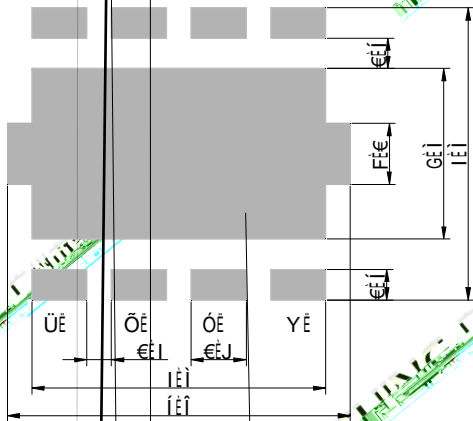

ÜÉ

ÜÉ

TYANSHINE

广州市添鑫光电有限公司
Guangzhou Tianxin Photoelectric Co., Ltd.

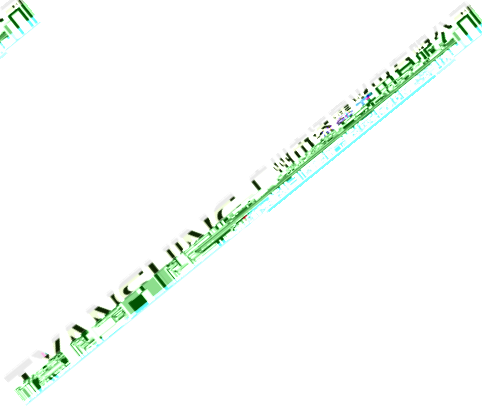
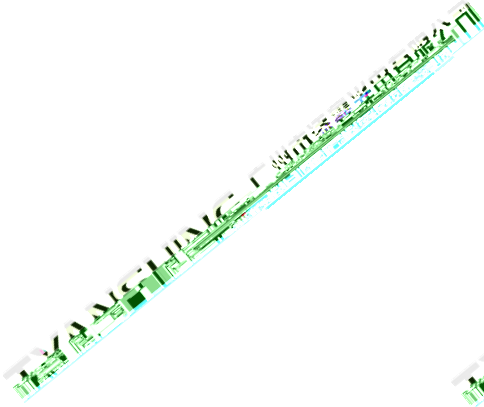
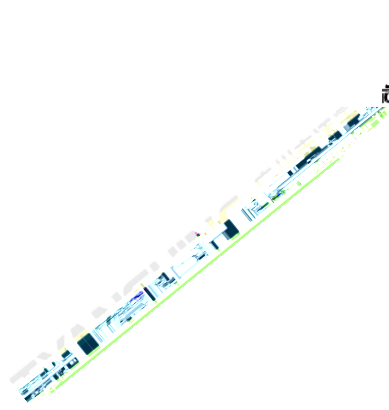
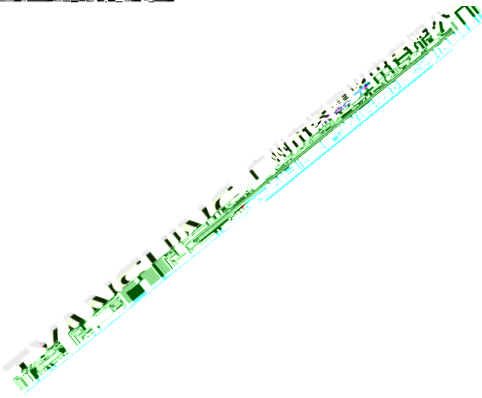

TYANSHINE 广州市添鑫光电有限公司

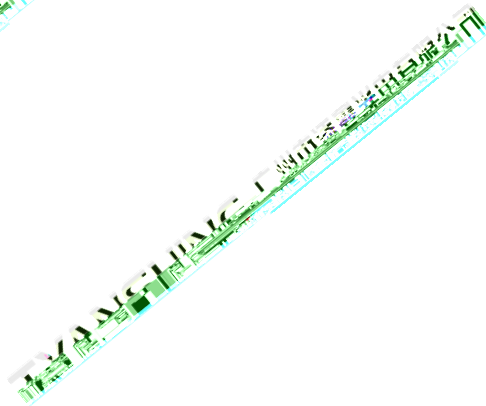
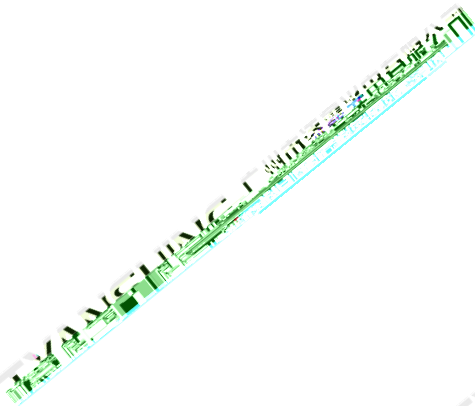

TYANSHINE 广州市添鑫光电有限公司
Guangzhou Tianxin Photoelectric Co., Ltd.

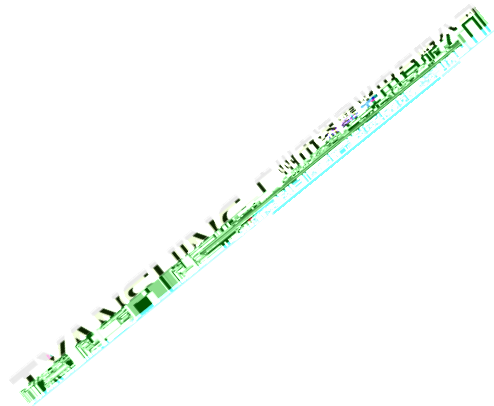
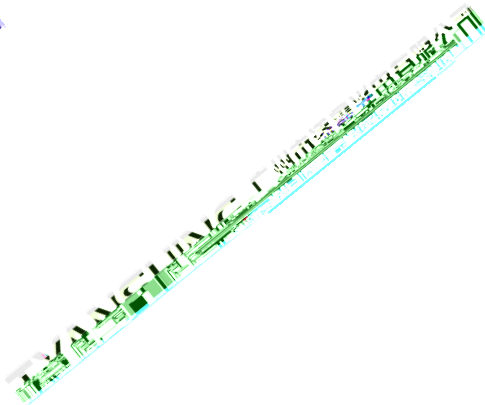
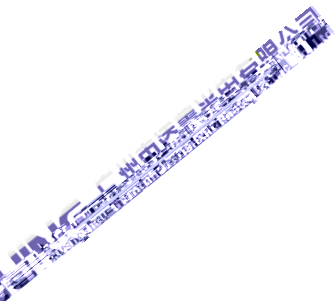

Úælc P[È VÝÉÍÉÍÜÖÓYFεØÔFGÉËPÖXÔPÖHIÈÉÓ
@cc]KDD , , Éç|/âÈ&}

Ù] ^ & P[È YSØÉÓÒ€GFF Úæ*^
X^!•â[}KFE€

Electrical Optical Characteristics (Tc=25°C)

Parameter	Symbol	Condition	Emitting Color	Min.	Typ.	Max.	Units
Spectral Radiance	L _λ	Q-M	U	FF	FH	FI	lm/W
			O	FJ	GH	GI	
			O	HE	IE	II	
			Y	GE	GH	GI	
Spectral Radiance	L _λ	Q-M	U	IF	IG	IH	lm/W
			O	IJ	IG	IJ	
			O	II	II	II	
Spectral Radiance	L _λ	Q-M	U	IHE	IIE	IEE	S
			O	IF	IF	IG	
			O	II	IF	II	
Spectral Radiance	L _λ	Q-M	U	IG	IHH	IHI	lm/W
			O	IF	IF	IG	
			O	II	IF	II	
			Y	GI	HI	II	
Spectral Radiance	L _λ	Q-M	U	GE	GEH	GEI	X
			O	HE	HEH	HEI	
			O	HE	HEH	HEI	
			Y	HE	HEH	HEI	
Spectral Radiance	L _λ	Q-M	U	.	.	I	μE
			O	.	.	I	
			O	.	.	I	
			Y	.	.	I	
Spectral Radiance	L _λ	Q-M	U	.	FG	.	Ö*
			O	.	HEI	.	
			O	.	HEI	.	
			Y	.	HEI	.	
Spectral Radiance	L _λ	Q-M	U	.	EG	.	{XØ
			O	.	EHÉI	.	
			O	.	EG	.	
			Y	.	EH	.	

White light Color coordinate filing (IF=700mA)

Grade	TC	P1		P2		P3		P4	
		X1	Y1	X2	Y2	X3	Y3	X4	Y4
2D	íH€€ È íí€€S	€€HHíí	€€HHíJ	€€HGJ€	€€HHFF	€€HGJ€	€€HIGí	€€HHíF	€€HIJJ
2A	íí€€ È í€€€S	€€HGJ€	€€HGJH	€€HGGG	€€HGíH	€€HGíí	€€HHí€	€€HGJ€	€€HíFí

Notes:

FÈŠ { à } [~ • à } c ^ } • à c ^ { ^ æ ~ ! ^ à , à c @ æ | à * @ c • ^ } • [! æ } à - à | c ^ } & [{ à à } æ c à [] c @ æ c æ] ! [ç à { æ c ^ • c @ } Ó Ò
 ^ ^ à È ! ^ • [] • ^ & ~ ! ç à È

GÈ FÈG à • c @ ^ [~ È ç à • æ } * ! ^ æ c , @ à & @ c @ ^ | ~ { à } [~ • à } c ^ } • à c ^ • @ æ | ~ c @ ^ æ ç à æ | ~ { à } [~ • à } c ^ } • à c ^ È

HÈV @ ^ a [{ à } æ } c , æ ç ^ / ^ } * c @ ç à D à • à ^ í ç ^ à , ! [{ c @ ^ Ó Ò & @ ! [{ æ c à & à c ^ à à æ * ! æ { æ } à / ^ ! ^ • ^ } c • c @ ^ • à } * ! ^
 æ ç ^ / ^ } * c @ , @ à & @ à ^ - à } ^ • c @ ^ & [[! [~ c @ ^ à ^ ç à & à È

íÈŠ { à } [~ • - | ~ ç { ^ æ ~ ! ^ { ^ } c c [| ^ ! æ } & K í F í Æ È

íÈØ [! , æ í à ç [| ç æ * ^ { ^ æ ~ ! ^ { ^ } c c [| ^ ! æ } & ^ K í € F í X È

Typical Electrical/Optical Characteristics Curves

CGÍ Œ { àâ^}c V^ {]^!æc~!^ W} |^•• Ūc@^! , à•^ Þ [c^âD

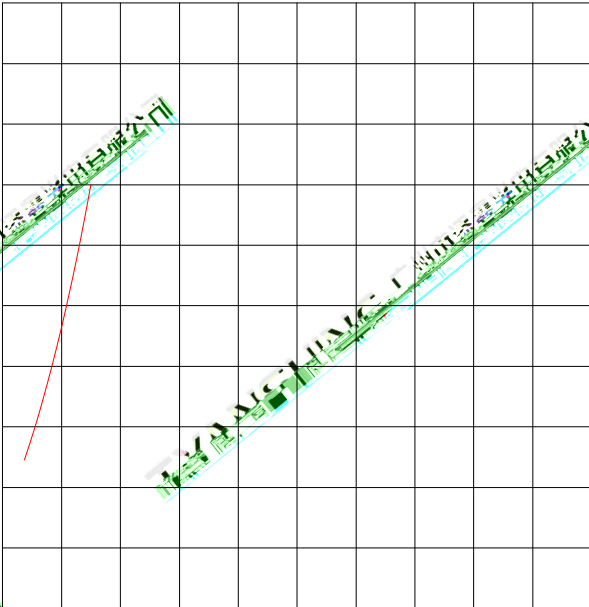

-
-
-
-

TYANSHINE 广州市添鑫光电有限公司
Guangzhou Tianxin Photoelectric Co., Ltd.

Úæ!c Þ [È	VÝËÍÉÍËÜÖÓY FËØÔFGËËÞÖXÔÞÖHIËËÓ	Û] ^ & Þ [È	Y SØËÓÒËGFF	Úæ*^	î [- FË
-----------	---------------------------------	-------------	-------------	------	---------

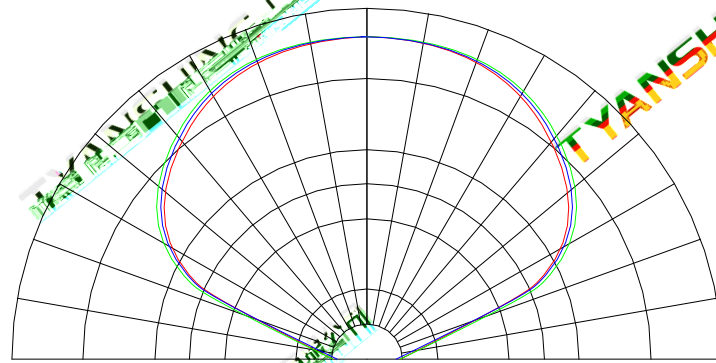
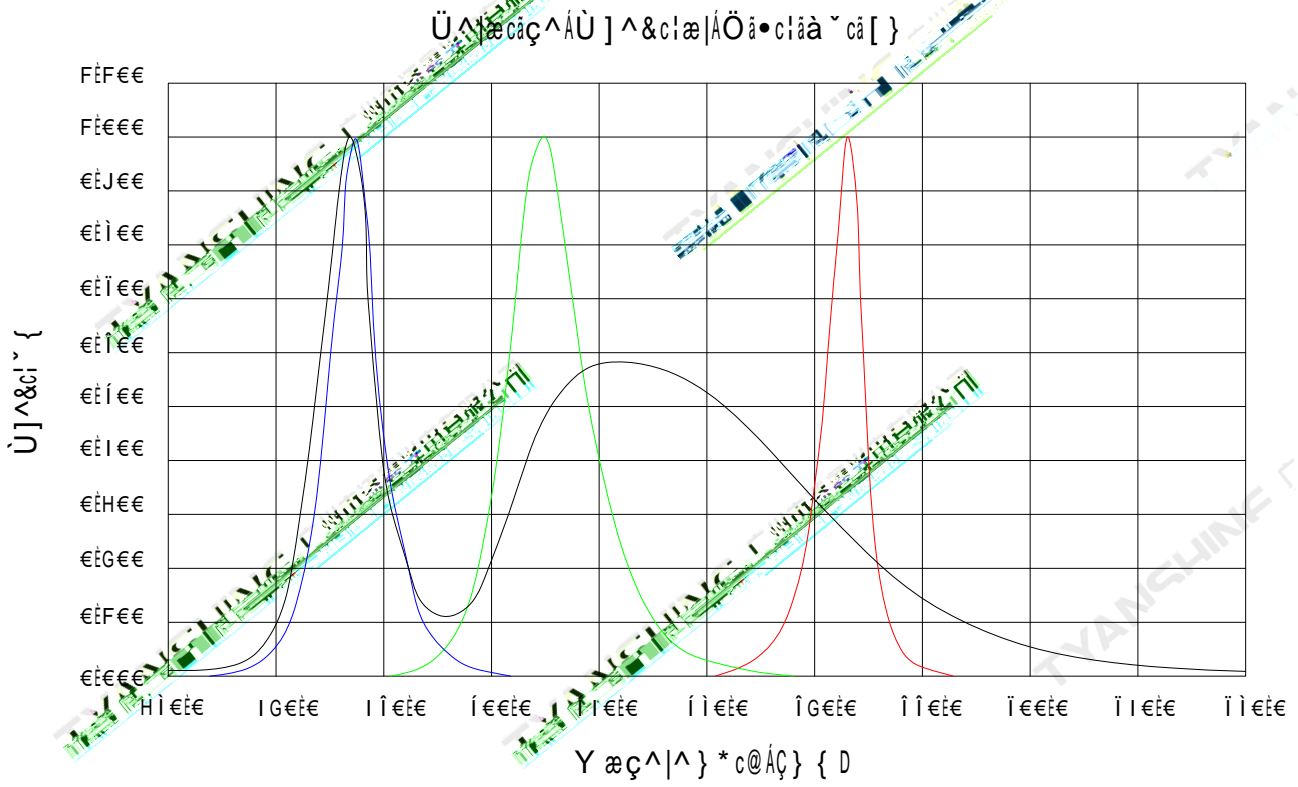

Notes:

FÈ G FØG ä • ç @ ^ [~ æ ç • æ } * | ^ ~ | [{ } æ { } & ^ } ç ^ | ä ^ , @ ^ | ^ ç @ ^ | ~ { ä } [~ • ä } ç ^ } • ä ç ^ ä • FØG [~ ç @ ^] ^ æ \ ç æ | ~ ^ È
 GÈ X ä ^ , æ } * | ^ ç [| ^ ä } & ^ ä • † | » È

Ü] ^ & ç ä Ö ä • ç ä ä ~ ç ä [}	VÝÉÍÉÍÉÜÖÓY FÈØØFGÈÈÈÞÖXÔÞÖHIÈÈGÓ	Ü] ^ & ç ä Ö ä • ç ä ä ~ ç ä [}	Y SØÈÓÒÈGFF	Ü æ ^ ^ ì [~ FÈ
@cc]KDD , , Èçø ^â&}				X ä ! • ä [} K F È È

TYANSHINE

广州市添鑫光电有限公司
Guangzhou Tianxin Photoelectric Co., Ltd

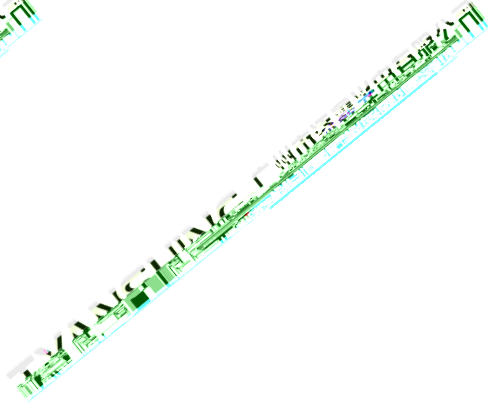
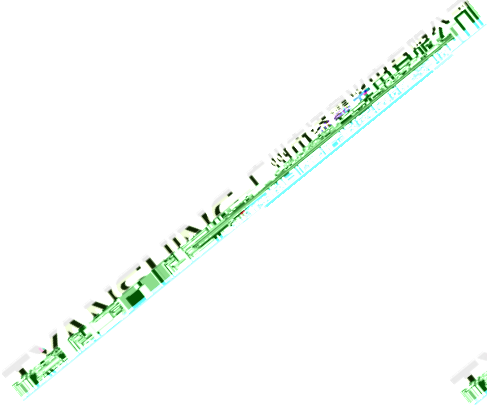
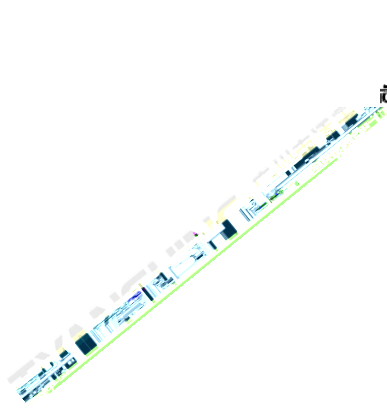
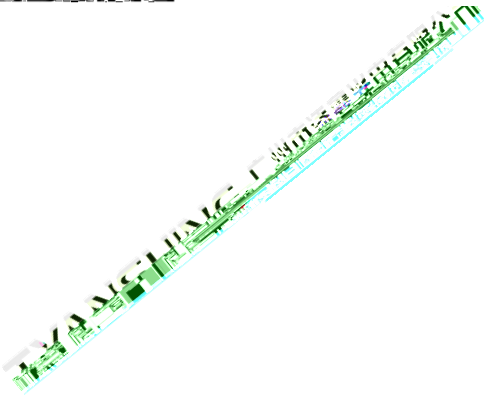

TYANSHINE 广州市添鑫光电有限公司

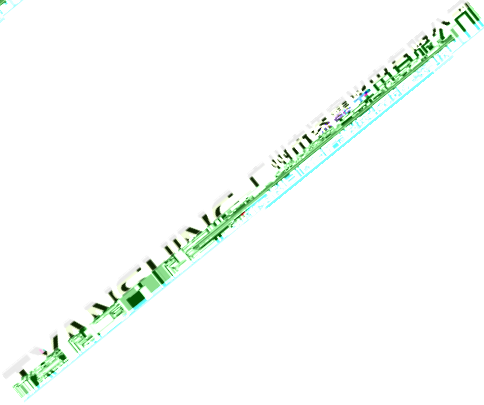
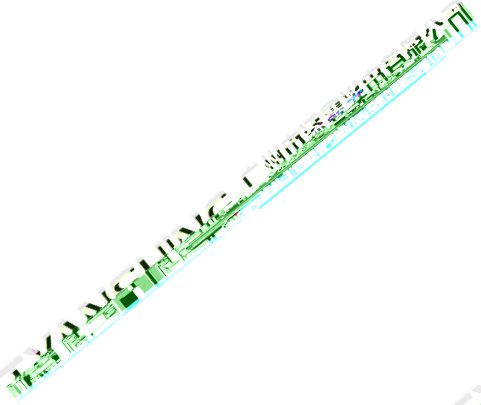

TYANSHINE 广州市添鑫光电有限公司
Guangzhou Tianxin Photoelectric Co., Ltd

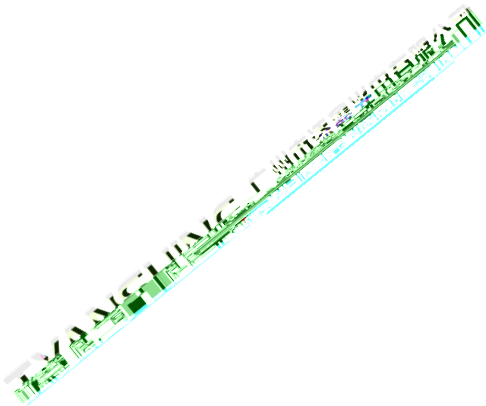
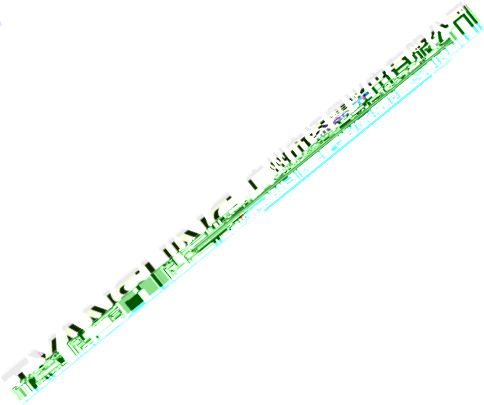
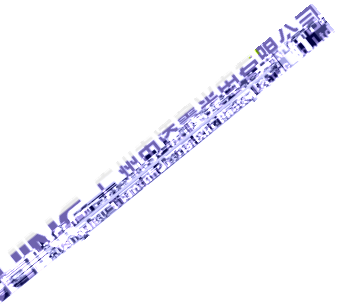

Úæic P[È

@cc]KDD , , Ècø|^âÈ&}

X^!•â[}KFÈ€

Dimensions For Cannulation And Packaging

Quantity: 500PCS

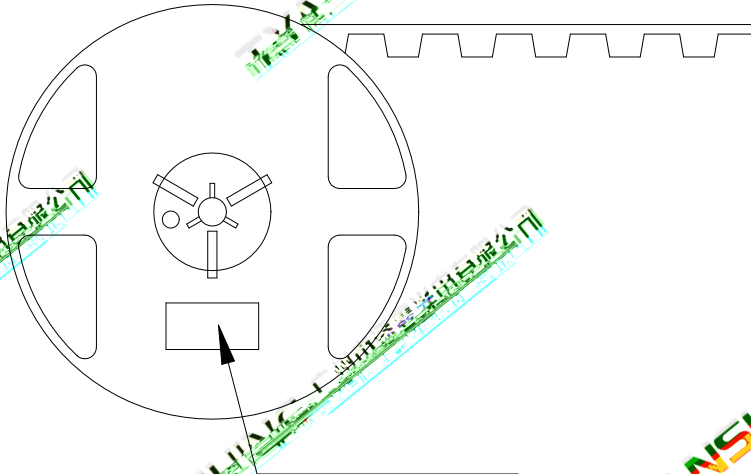
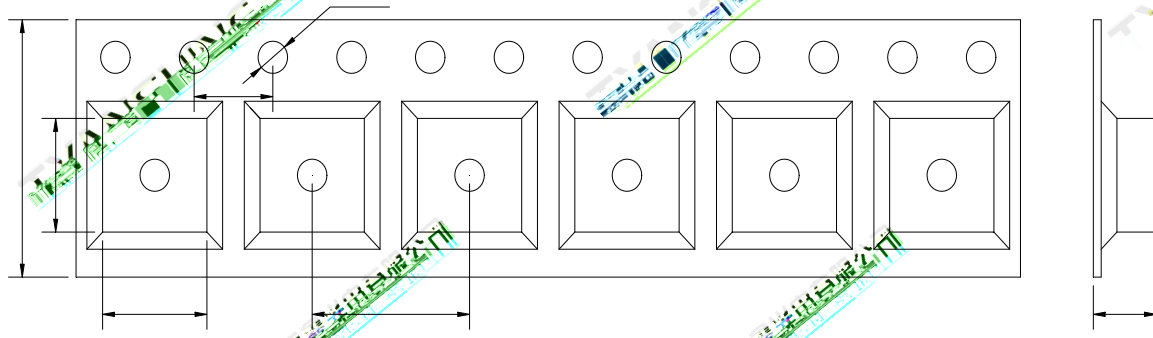

Notes:

FÈ CE|| áá { ^ } • ä { } • æ! ^ ä } { ä|lä { ^c^! • È
 GÈ V| |^!æ } & ^ • æ | GÈ€ { { ~ } | ^ • • [c@^! , ä ^ } [c^â È
 HÈ V@^] | | ä ^ & c • æ! ^] æ & \æ * ^ â c [* ^ c@^! , ä c@ • ä & æ * ^ È V!æ } • [| : È } [c c [c@^ ^ * @c [- , ^ | ä ä] * ŠÖÖ
 | ä * @c È ^ { äccä } * æ! ^ æ È CE • æ ! ^ • ~ | c [- c@^ , ^ ä * @c [- ŠÖÖ | ä * @c È ^ { äccä } * : [] ^ ä } c@^ ~ æ | æ [- È Q! ! ^ • [] • ä | ^ [- c@^
 Ô [{ ^] æ } ^ È

Úæ!c P [È	VÝÉÍÉÍÉÜÖÓY F€ØÔFGÈPÖXÔPÖHIÈ€Ó	Ù] ^ & P [È	Y SØÉÓÒ€GFF	Úæ * ^ F€ [- F€
@cc] KDD , , , Ècø ^â&€ }				X^! • ä [] K F È €