

Package Dimensions:

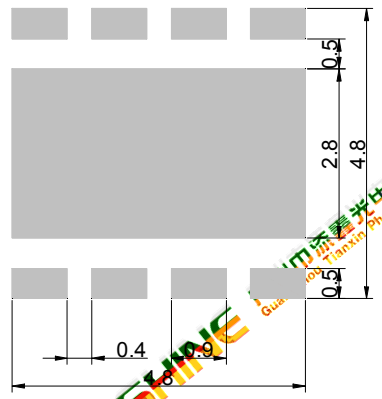
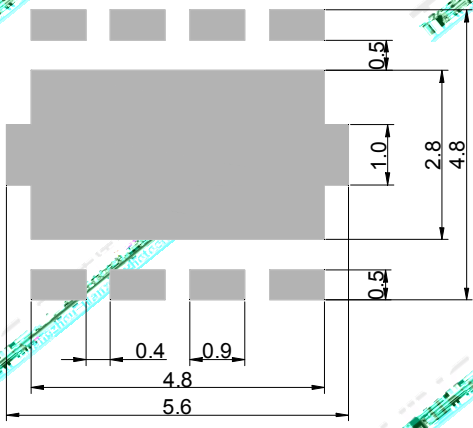
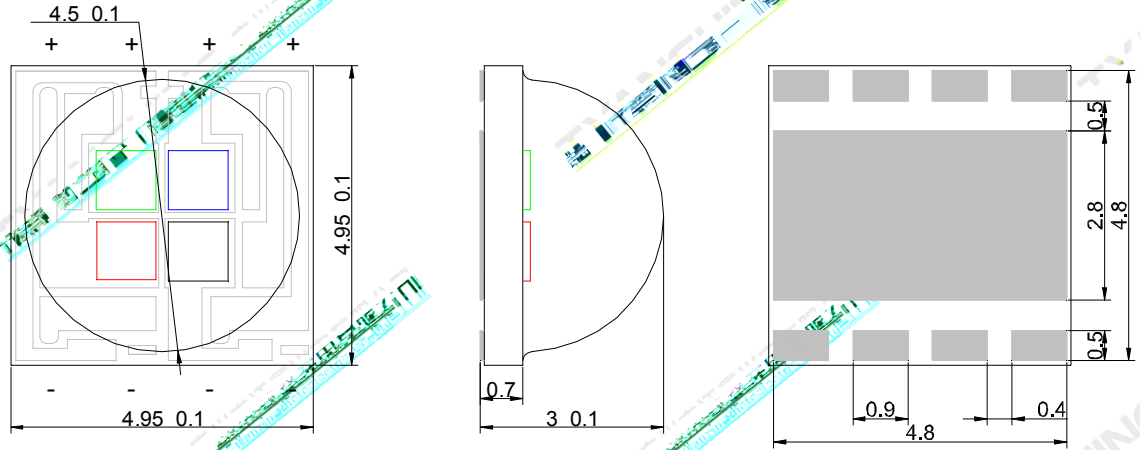

Notes:

- 1.
- 2.

.	-5050	10	120-	34-02	.	-	0211	2	10
---	-------	----	------	-------	---	---	------	---	----

Absolute Maximum Ratings (Tc=25)

Parameter	Symbol	Max Ratings	Unit
		1000	
		5	
		2700	
		3700	
		3700	
		3700	
		115	
		150	
		150	
		150	
()		2000	
		-40 70	

Notes:

- 1.
- 2.

Electrical Optical Characteristics (Tc=25°C)

Parameter	Symbol	Condition	Emitting Color	Min.	Typ.	Max.	Units
				110	130	155	
				190	235	265	
				30	40	55	
				200	230	270	
				618	623	628	
				519	524	529	
				450	455	460	
				6500	7000	7500	
				628	633	638	
				514	519	524	
		=700		446	451	456	
				10	15	20	
				30	35	40	
				15	20	25	
				25	35	45	
				2.0	2.3	2.7	
				3.0	3.3	3.7	
				3.0	3.3	3.7	
		=5		3.0	3.3	3.7	
				2			
				2			
				2			
50	2 1/2				120		
					3.7		/
					3.7		

-5050

10 120-

34-02

- 0211

4 10

					3.7	
					3.7	
	/	=700			-2	/
					-3.5	
					-2	
					-3	

White Color coordinate filing (IF=700mA)

				1	1	2	2	3	3	4	4
11	6500	7000	0.3138	0.3216	0.3067	0.3143	0.3044	0.3259	0.3121	0.3331	0.3331
	7000	7500	0.3071	0.3125	0.3012	0.3064	0.2988	0.3154	0.3051	0.3221	0.3221

Notes:

- 1.
2. 1/2
3. ()
4. : 15%.
5. : 0.15 .

	-5050	10	120-	34-02		-	0211		5	10
--	-------	----	------	-------	--	---	------	--	---	----

Typical Electrical/Optical Characteristics Curves

(25

)

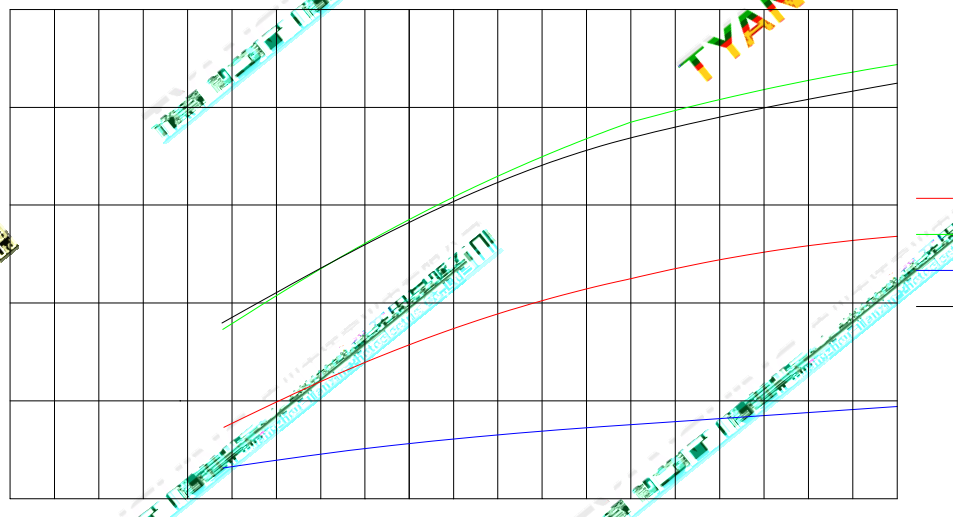
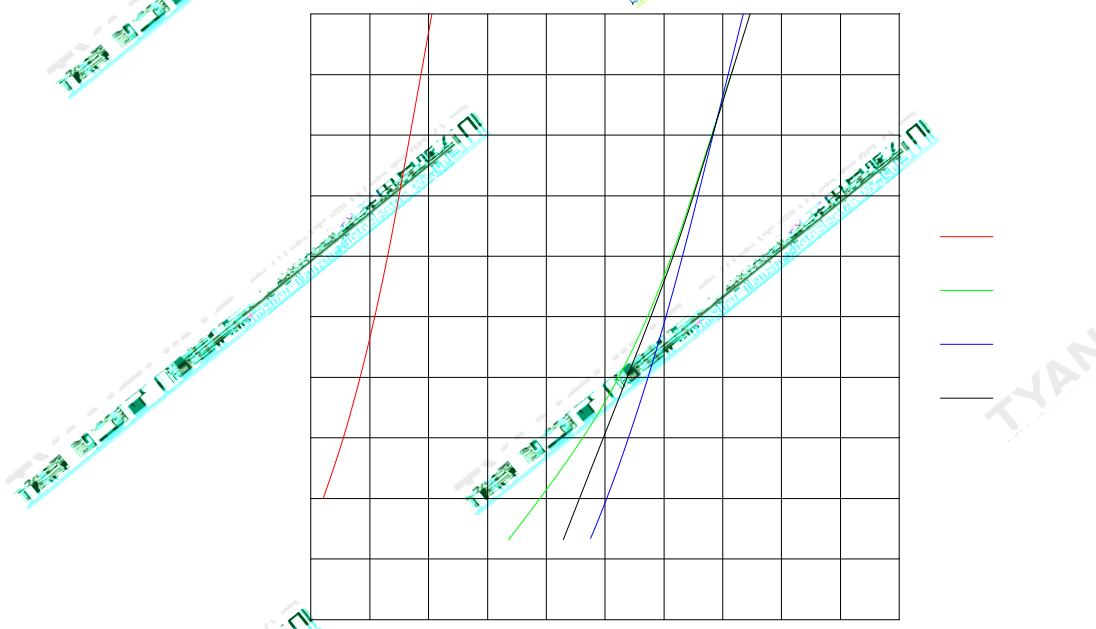

.	-5050	10	120-	34-02	.	-	0211	6	10
---	-------	----	------	-------	---	---	------	---	----

://

:1.0

(=700)

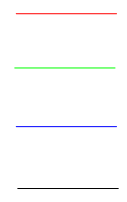
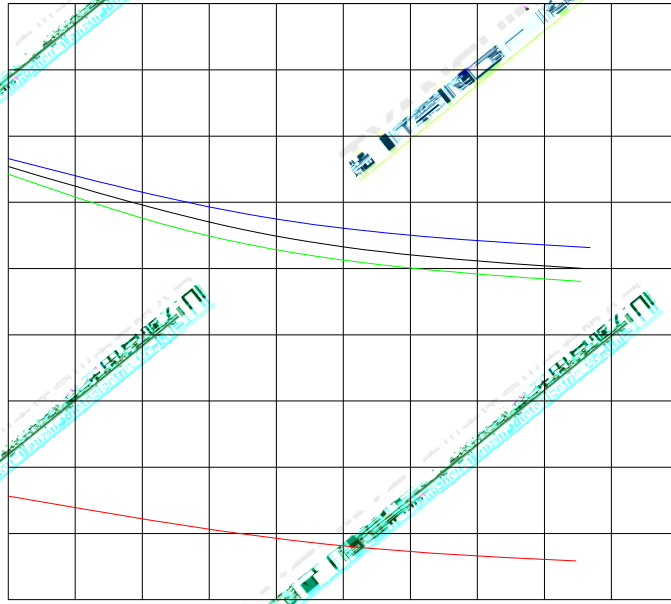

()

(=700)

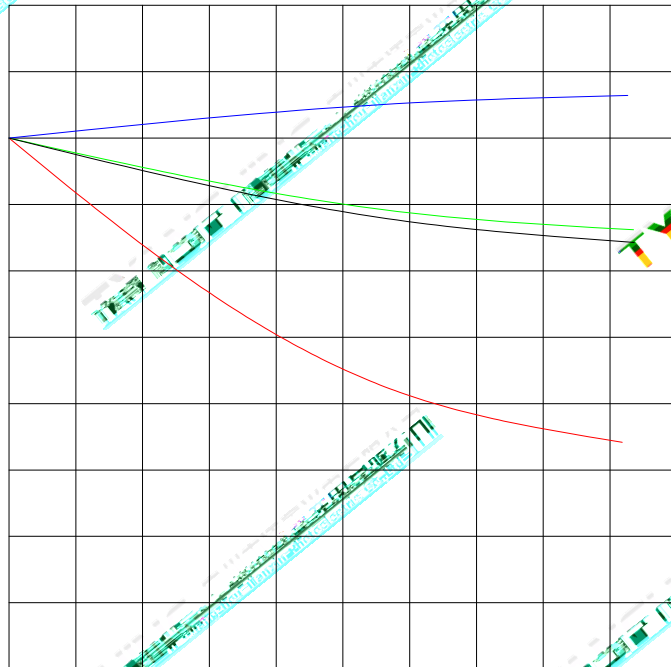

()

-5050

10 120-

34-02

- 0211

7 10

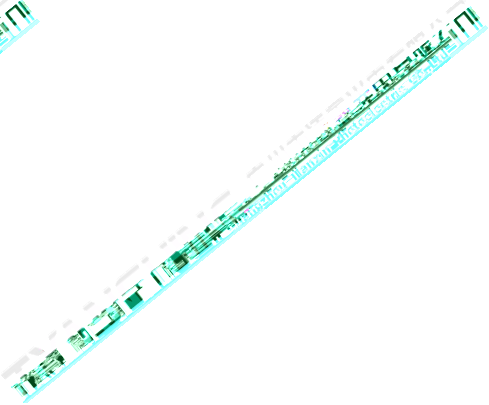
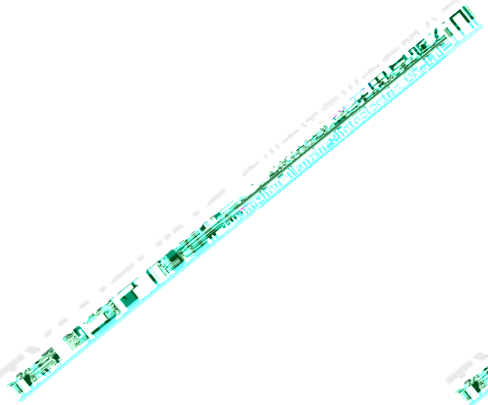
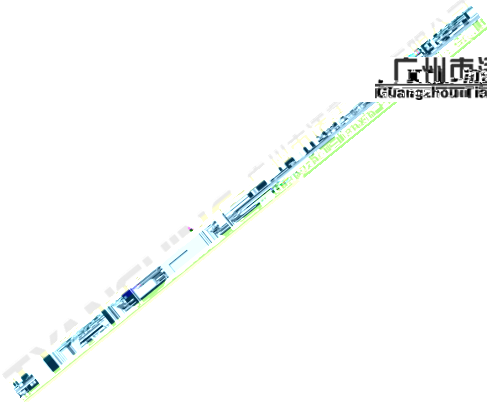
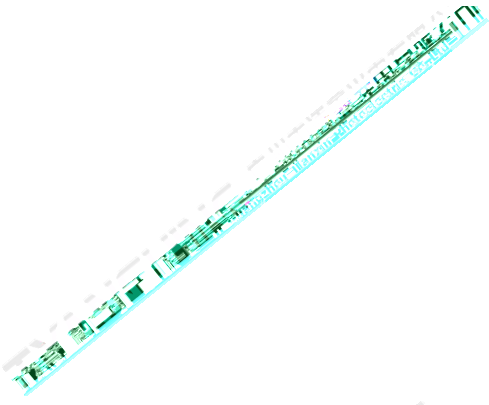

TYANSHING 广州市添量光电有限公司

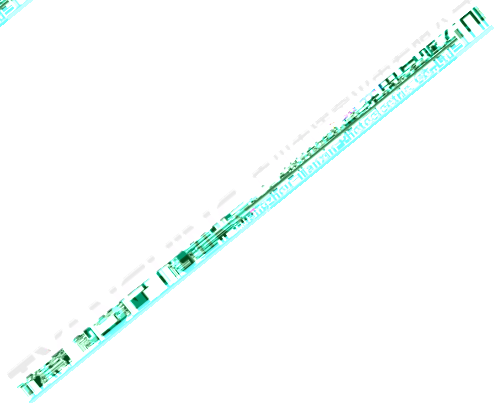
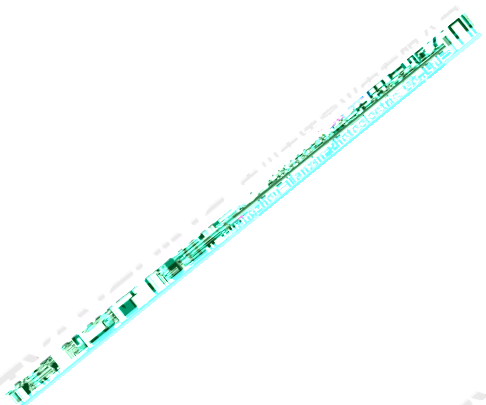

TYANSHING 广州市添量光电有限公司
Guangzhou Tianliang Photoelectric Co., Ltd.

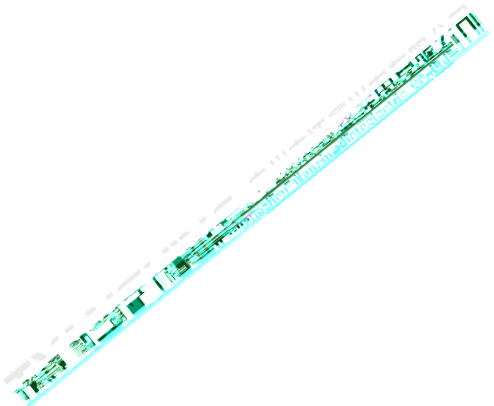
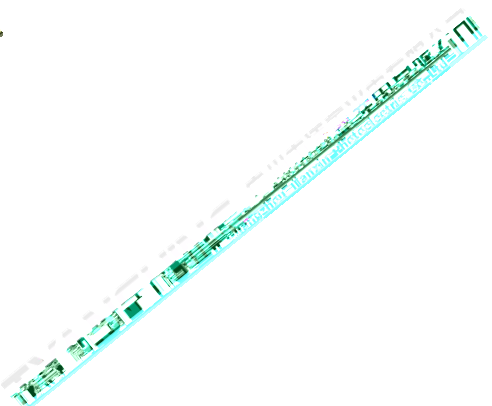

-5050

10

://

:1.0

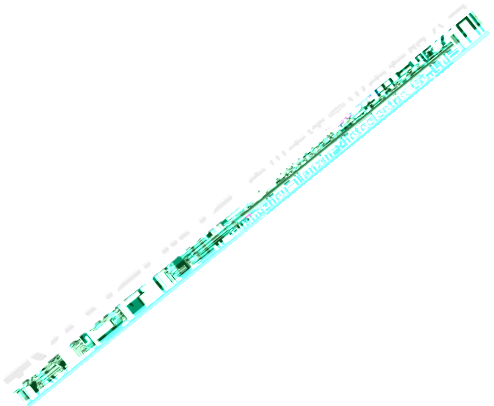
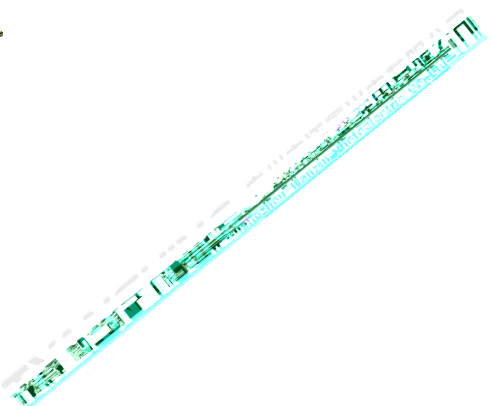
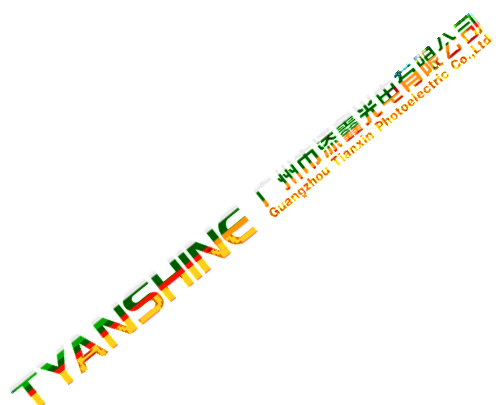
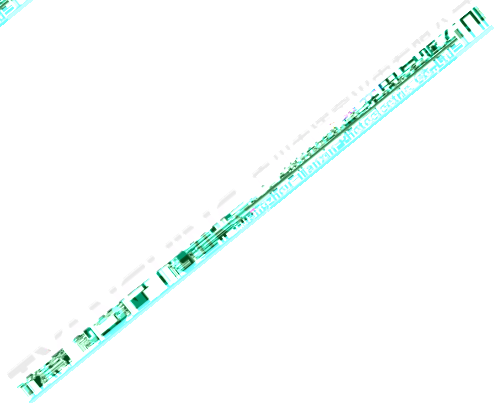
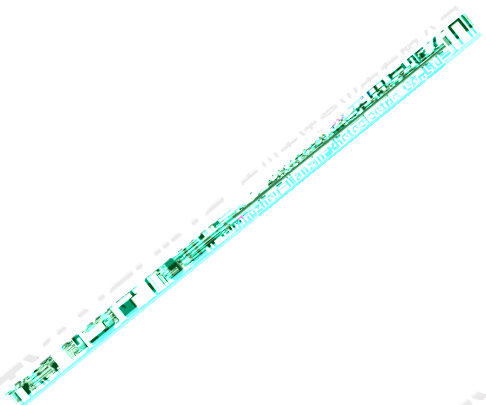
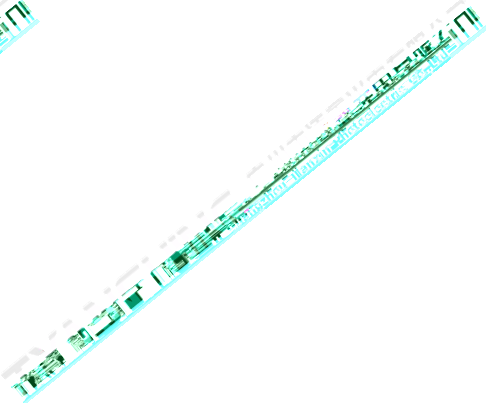
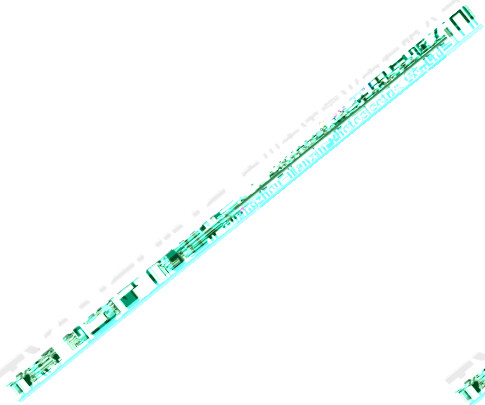
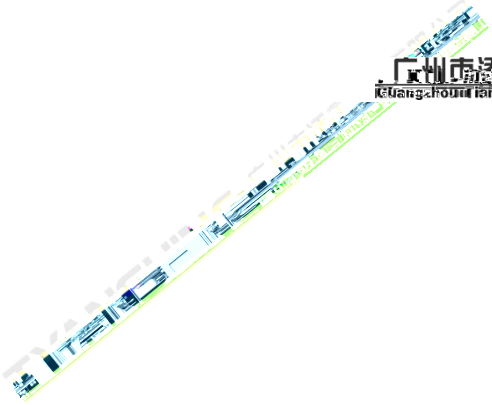
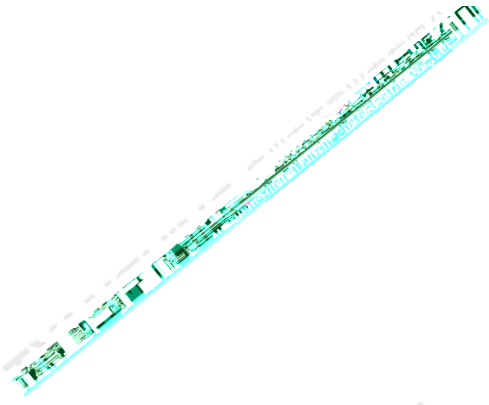

Dimensions For Cannulation And Packaging

Quantity: 500PCS

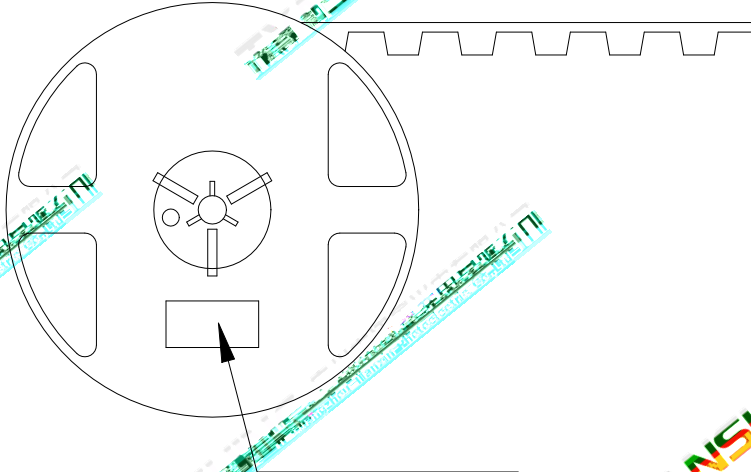
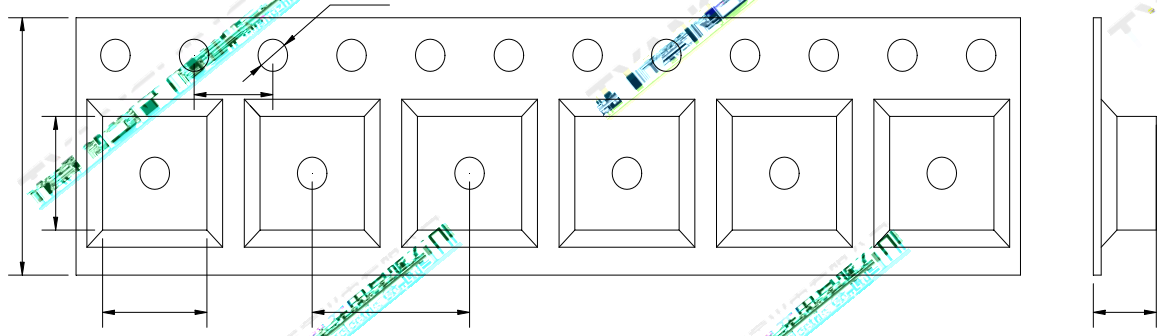

Notes:

- 1.
2. 2.0
- 3.

	-5050	10	120-	34-02		-	0211	10	10
--	-------	----	------	-------	--	---	------	----	----