

TYANSHINE 广州市添鑫光电有限公司

TYANSHINE 广州市添鑫光电有限公司

TYANSHINE 广州市添鑫光电有限公司

TYANSHINE 广州市添鑫光电有限公司

TYANSHINE 广州市添鑫光电有限公司

TYANSHINE 广州市添鑫光电有限公司

TYANSHINE 广州市添鑫光电有限公司

TYANSHINE 广州市添鑫光电有限公司
Guangzhou Tianxin Photoelectric Co., Ltd.

TYANSHINE 广州市添鑫光电有限公司

TYANSHINE 广州市添鑫光电有限公司

TYANSHINE 广州市添鑫光电有限公司

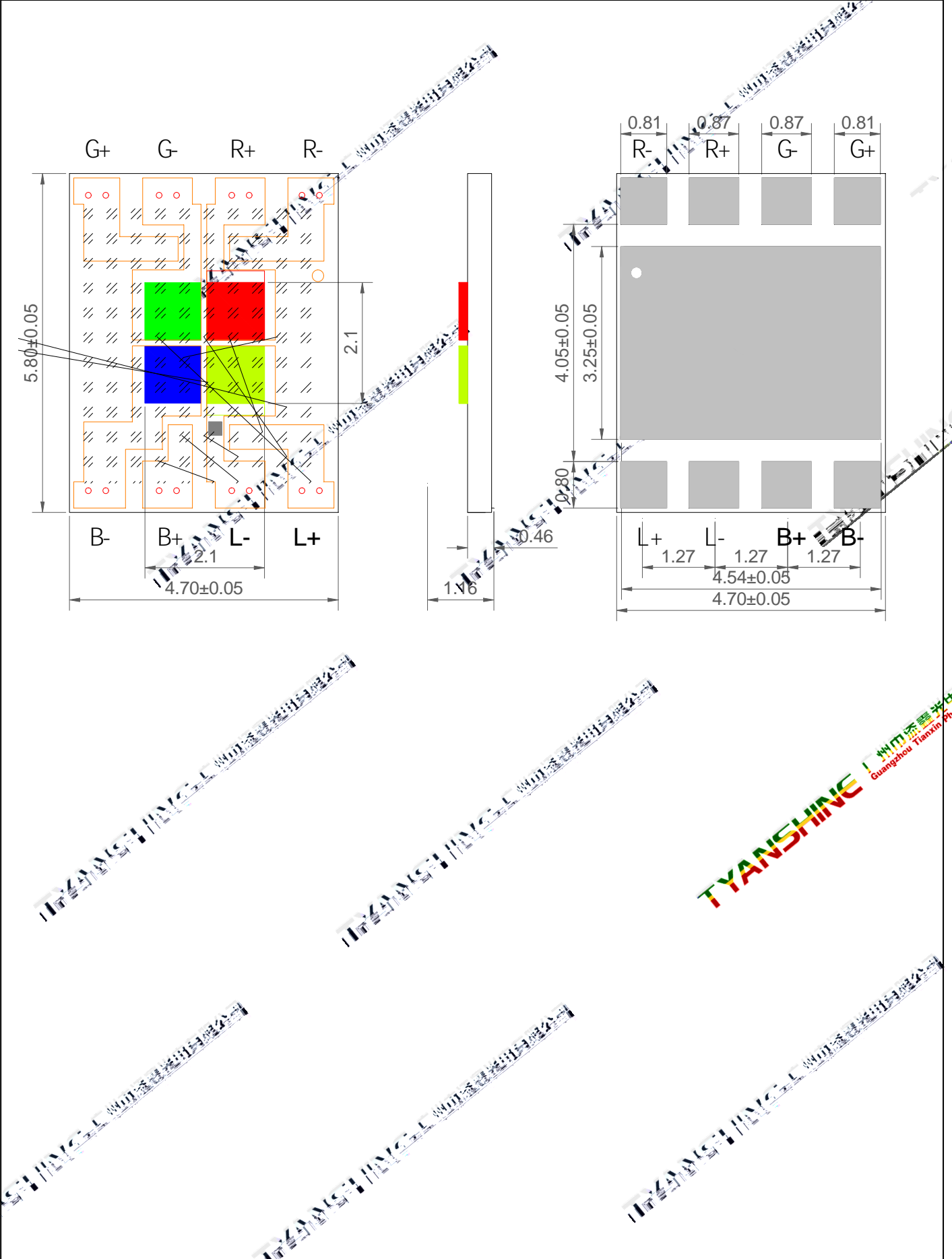

Forward Current	IF	R G B L	1.5 1.5 1.5 2.0		A
Reverse Voltage	V _R		Not designed for reverse operation		V
Power Dissipation	P _D	R G B L	3.8 5.4 5.1 6.7		W
Junction Temperature	T _j	R G B L	115 150 150 150		
Electrostatic Discharge Threshold (ESD)	ESD		2000		V
Storage Temperature					

1. Specifications are subject to change without notice.

2. The data on this specification is for reference only and the actual data is in accordance with the acknowledgment.

3. Precautions for ESD:

STATIC SHIELD Electricity and surge damages the LED. It is recommended to use a wrist band or anti-electrostatic glove when handling the LED. All devices, equipment and machinery must be properly grounded.

Luminous Flux	v	R	95	105	115	lm
		G	185	205	225	
		B	40	45	50	
		L	295	325	355	
Forward Voltage	V _f	R	2.0	2.4	2.8	V
		G	2.8	3.2	3.6	
		B	2.8	3.2	3.6	
		L	2.8	3.2	3.6	
Dominant Wavelength	d	R	618	623	628	nm
		G	520	525	530	
		B	448	453	458	
Peak-emission Wavelength	p	R	628	633	638	nm
		G	513	518	523	
		B	443	448	453	
Correlated Colour Temperature	CCT	L	4250	—	4500	K
Viewing Angle at 50 IV	2 1/2	—	—	120	—	Deg
Reverse Current	I _R : V _R =10V	R	—	—	2	μA
	I _R : V _R =7V	G	—	—	2	
		B	—	—	2	
	I _R	L	Not designed for reverse operation			
Thermal Resistance Junction to Case	R _{J-C}	—	—	0.8	—	K/W

- 1.Luminous intensity is measured with a light sensor and filter combination that approximates the CIE eye-response curve.
2. 1/2 is the off-axis angle at which the luminous intensity is half the axial luminous intensity.
- 3.Luminous flux measurement tolerance:± 10%.
- 4.Forward voltage measurement tolerance:± 3%.
- 5.Pa measurement tolerance:± 2.

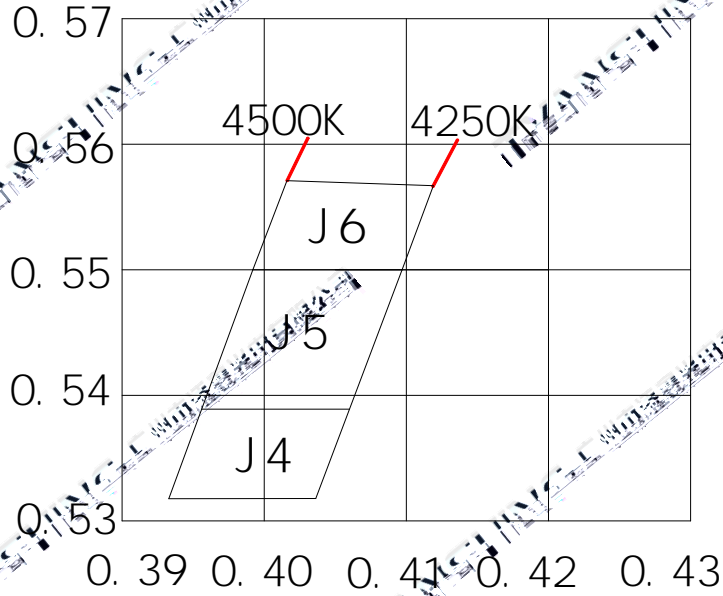

Region	CCT Range		X1	Y1	X2	Y2	X3	Y3	X4	Y4
	Min	Max								
J4	4250K	4500K	0.4036	0.5318	0.4060	0.5389	0.3956	0.5389	0.3933	0.5318
J5	4250K	4500K	0.4060	0.5389	0.4097	0.5500	0.3992	0.5500	0.3956	0.5389
J6	4250K	4500K	0.4097	0.5500	0.4119	0.5567	0.4016	0.5571	0.3992	0.5500

(25 Ambient Temperature Unless Otherwise Noted)

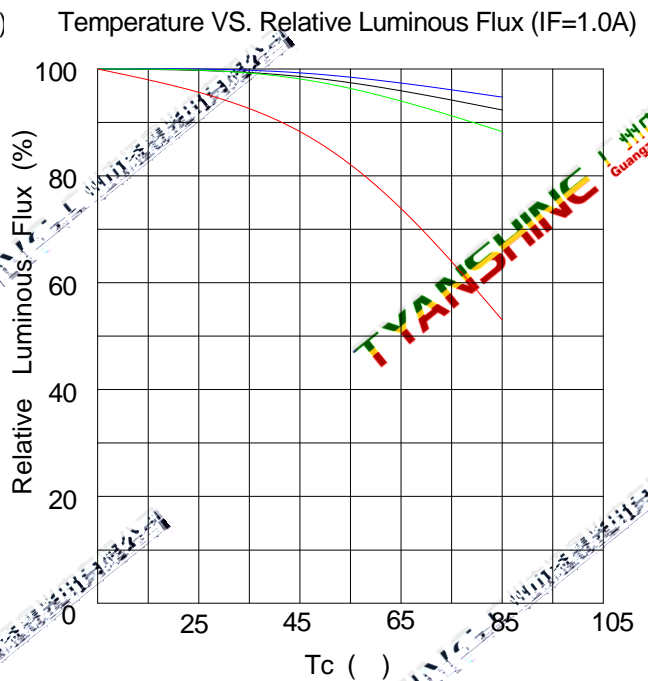
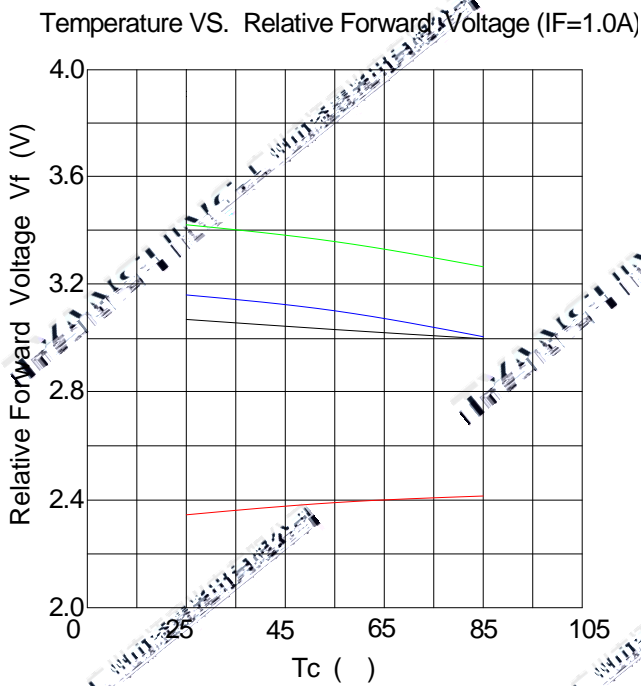
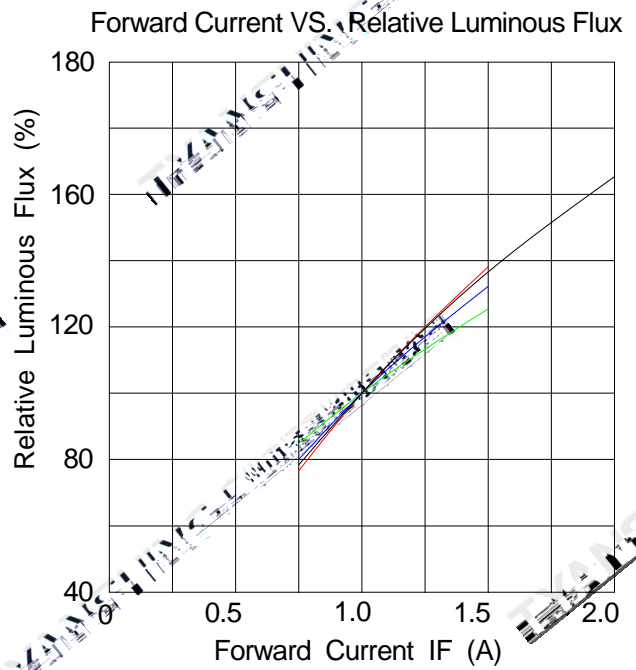
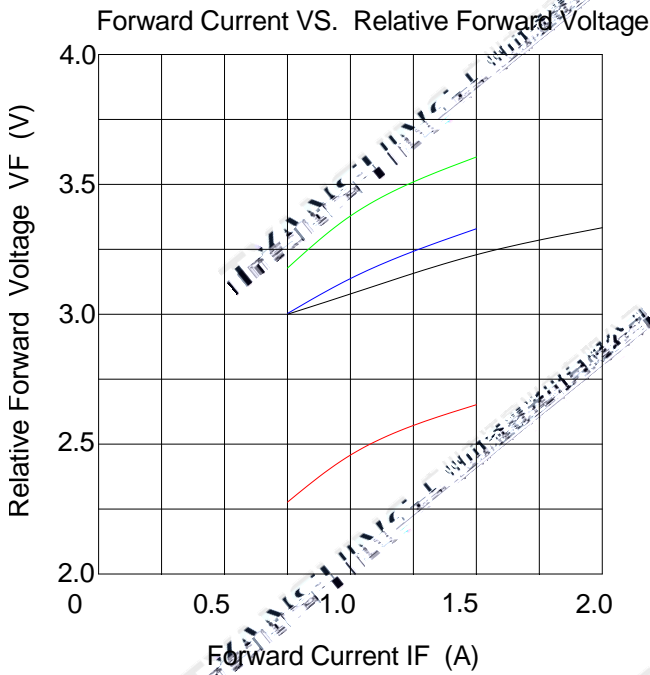

— Red R ; — Green G ; — Blue B ; — Lime L

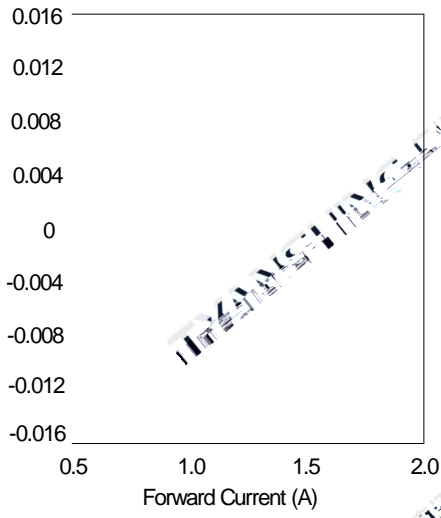

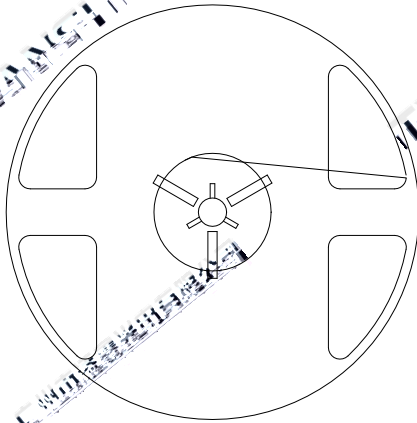
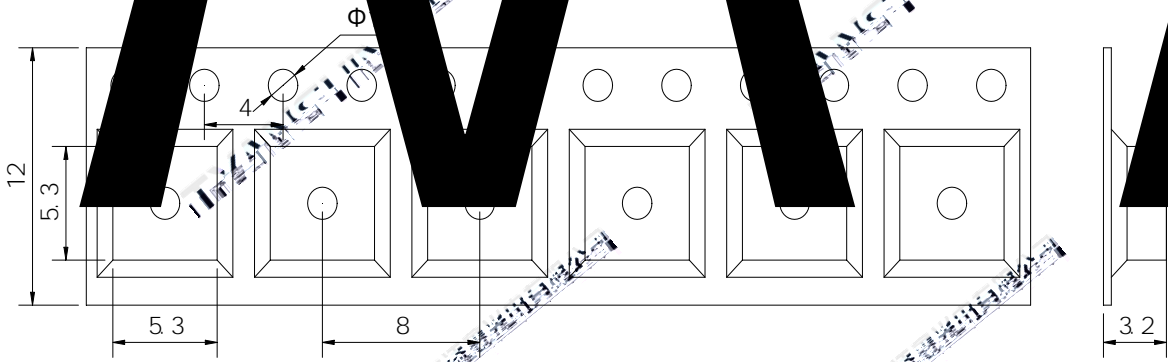

TYANSHING
广州市添鑫光电有限公司
Guangzhou Tianxin Photoelectric Co., Ltd.

